



# Powerful and compact

Explore our range

**HOEFLON®**



# Power with unexpected precision!

**Hoeflon designs, builds and sells minicranes, also known as compact cranes, spider cranes or minicrawlers.**

Hoisting in small areas, at a construction site, in an industrial setting or for installation purposes? Hoeflon has the perfect compact crane for any job. Flip through this booklet to see which minicrane best fits your hoisting job.

We use the following icons to show you each machine's specifications at a glance.



Capacity



Dimensions in transport position



Lifting height



Total weight

# C1e

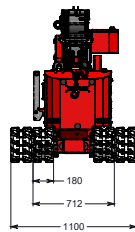
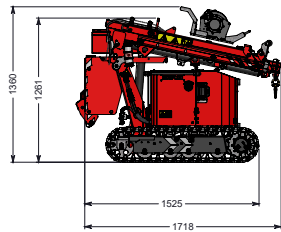
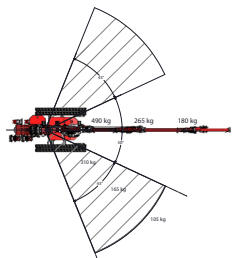
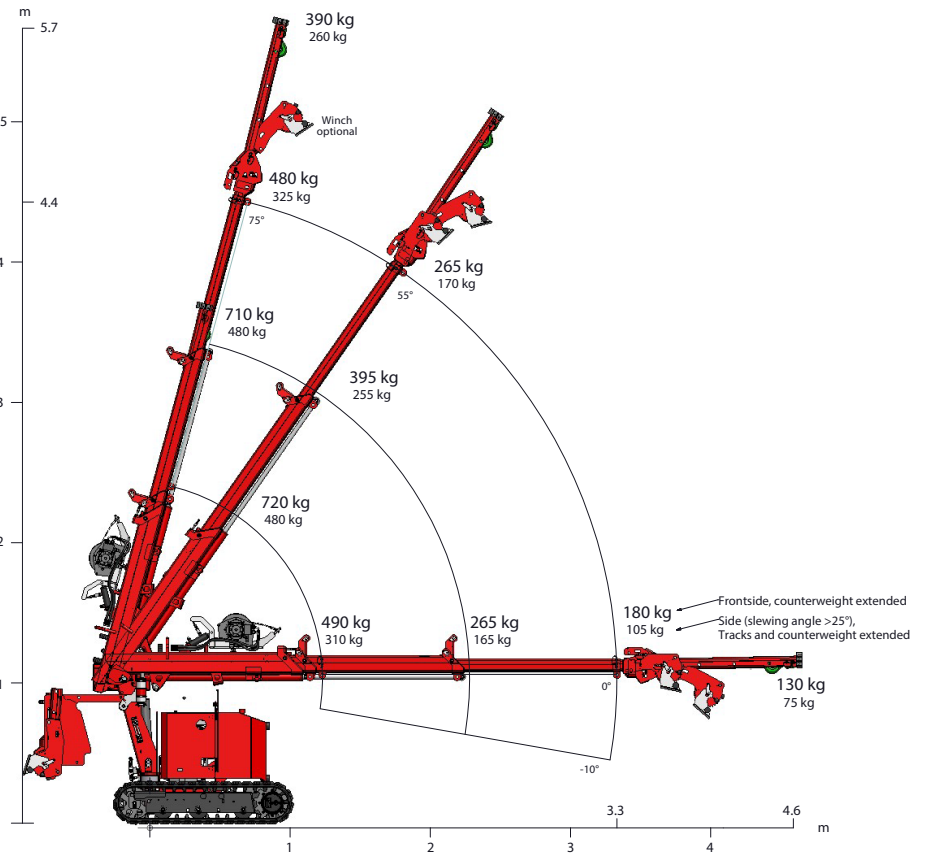

- ⚖ Max. 780kg
- ↕ 5,6m
- 📦 1,7 x 0,7 x 1,26m
- 🏠 960kg - 1.060kg

- › Operable with radio remote
- › Fits in a lift
- › Transportable in a van
- › Slews left and right
- › With hoisting winch
- › Pick and carry
- › Electric motor 230V

# C4e

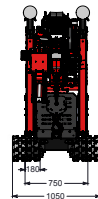
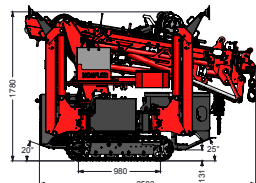
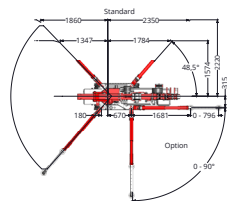
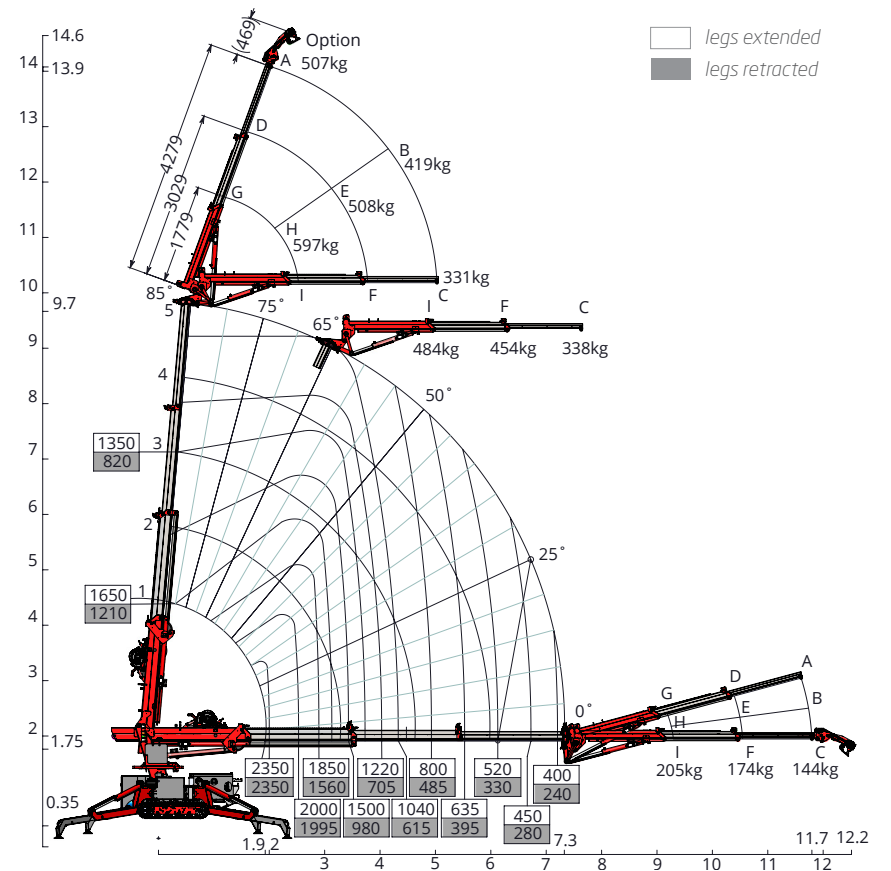

⚙️ Max. 2.350kg

↕ 14,6m

📦 2,6 x 0,75 x 1,78m

⚖️ 1.900kg - 2.150kg

› Operable with radio remote

› Low net weight

› Favourable lifting capacity

› Transportable on trailer

› Electric motor 230V

# C6e

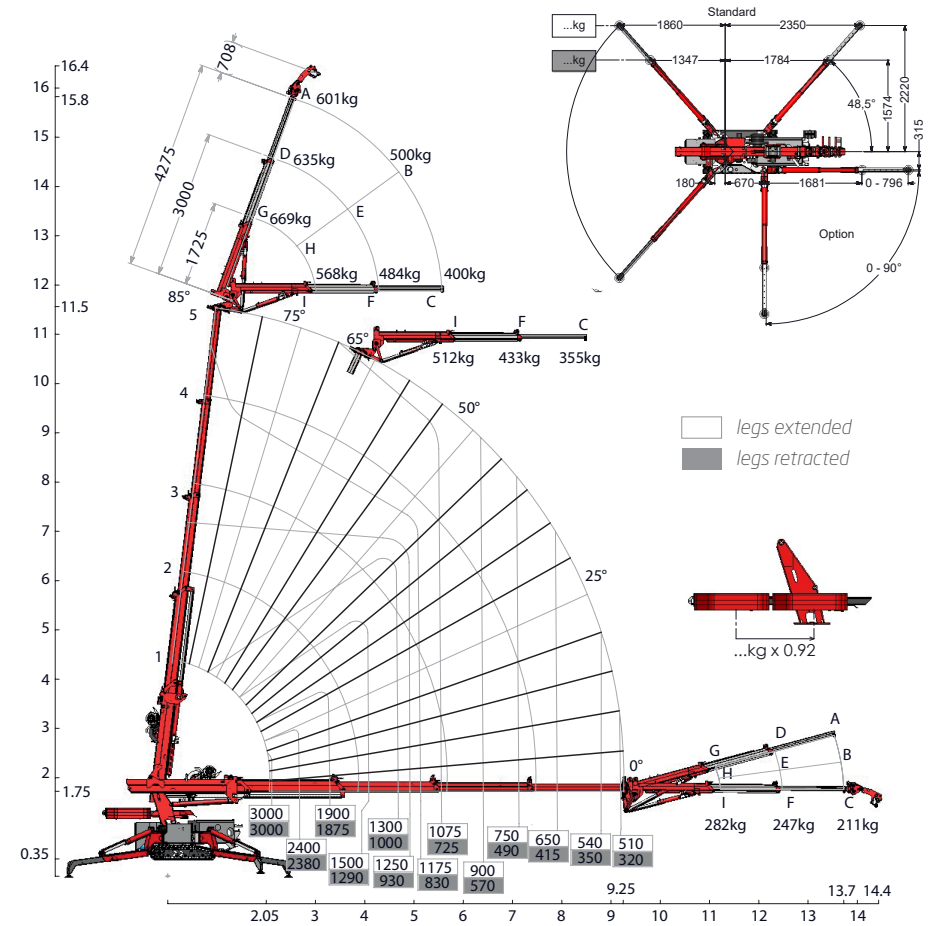
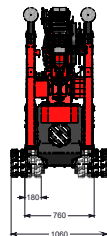
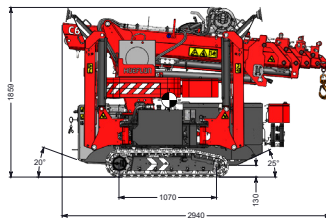
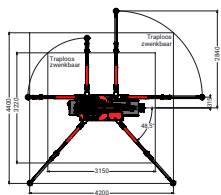

⚙️ Max. 3.000kg

↑↓ 16,4m

📦 2,7 x 0,75 x 1,77m

⚖️ 2.120kg - 2.850kg

› Operable with radio remote

› Transportable on trailer

› Extendible and removable counterweight

› Fits through every door

› Simple operation

› Electric motor 230V

# C10e

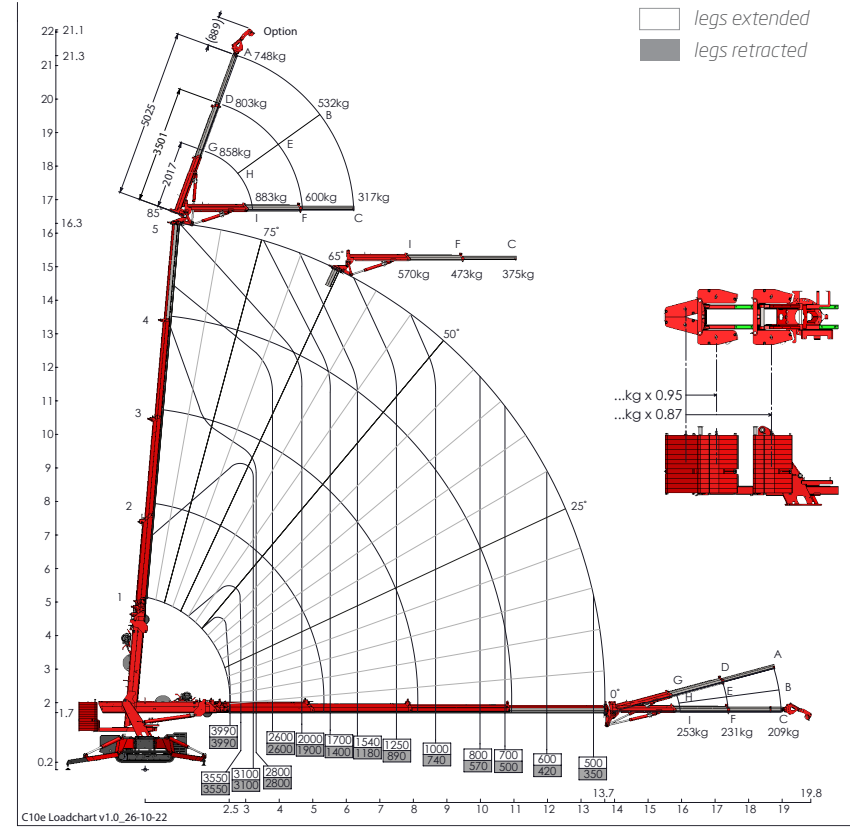
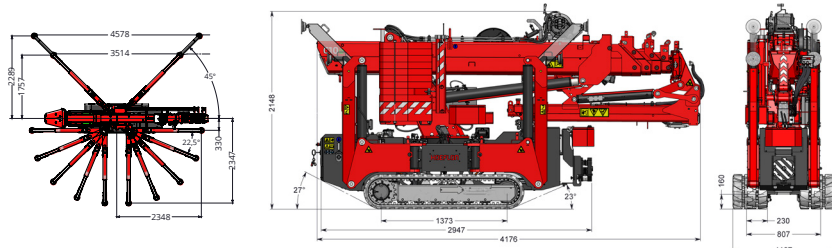

📏 Max. 4.000kg

↕ 22m

📦 4,18 x 0,807 x 2,15m

🏋️ 4.400 - 4.700kg

› Operable with radio remote

› Extendible and removable counterweight

› High lifting capacity

› Electric motor 230V

# C30e

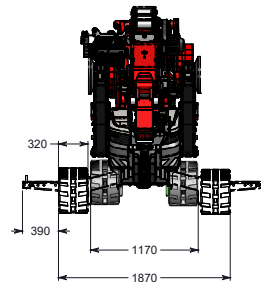
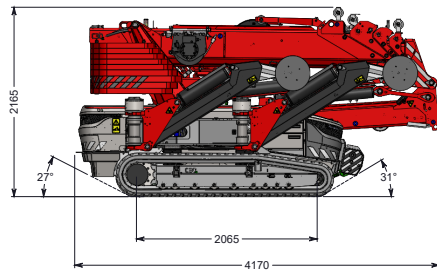
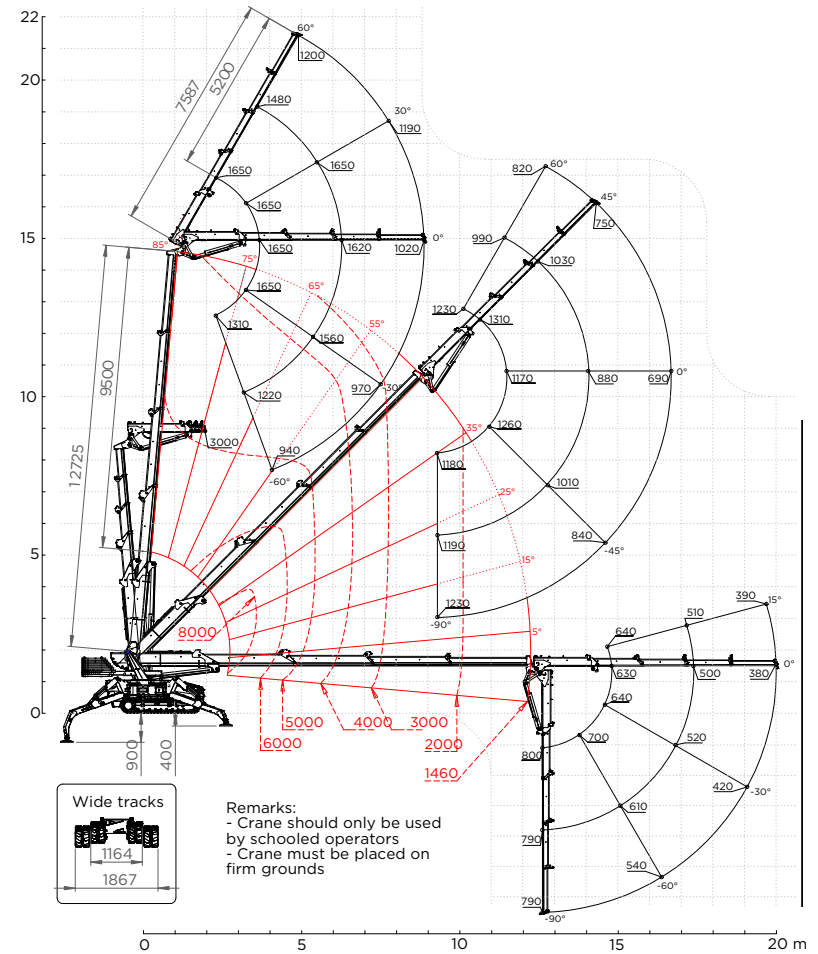

- ⚖ Max. 10.000kg
- ↕ 23m incl. handpart
- 📦 4,17 x 1,17 x 2,17m
- ⚖ 5.600 - 8.700kg
- › Operable with radio remote
- › Extendible and removable counterweight
- › High lifting capacity
- › Pick and carry
- › Electric motor 230V

# Multitool

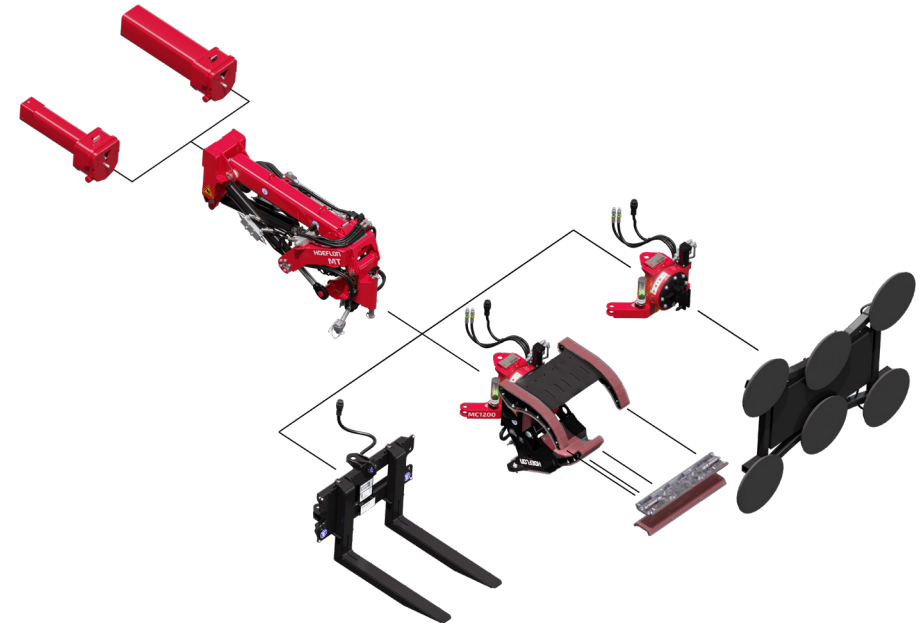
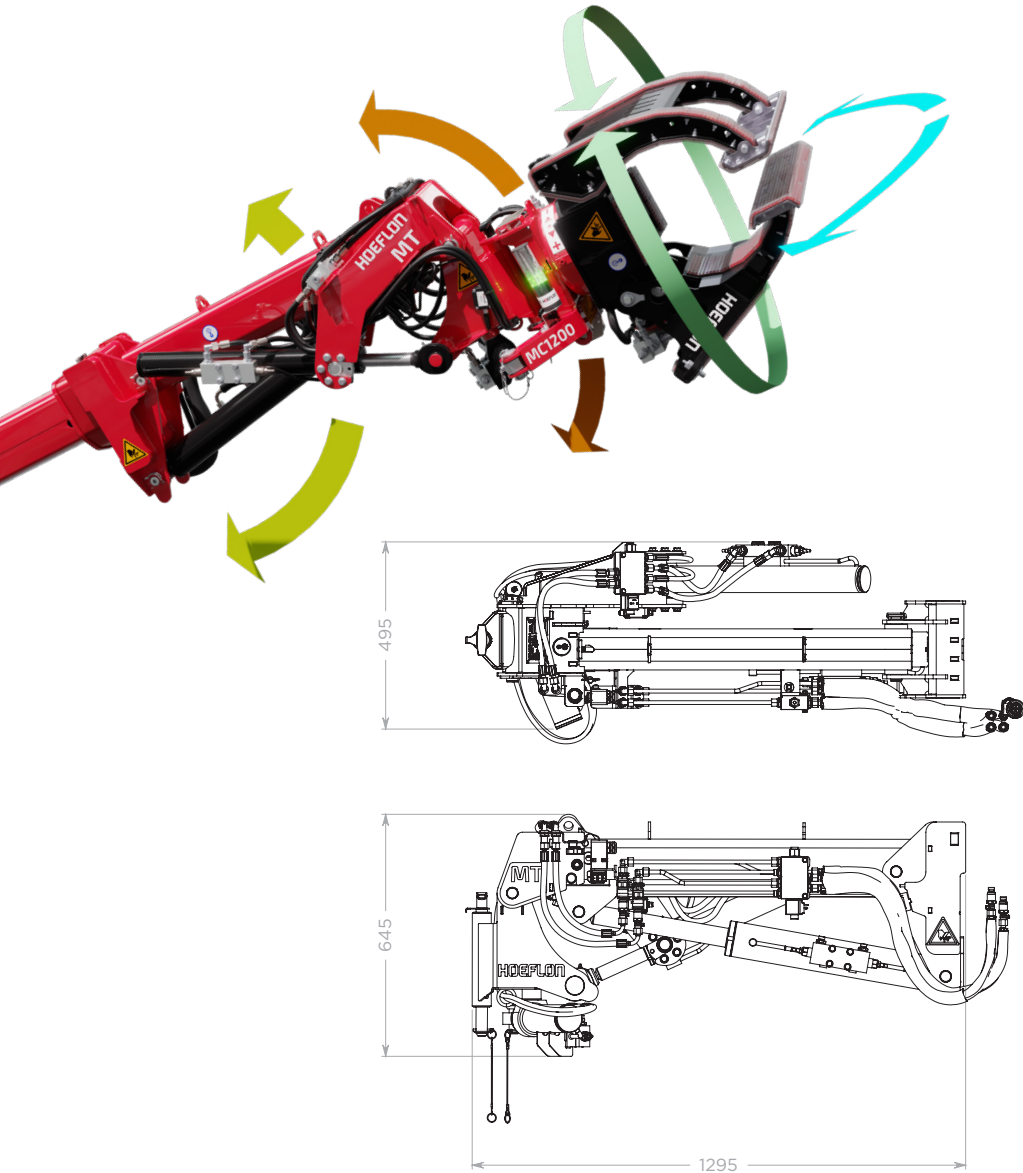

- › Multifunctional
- › Suitable for C4, C6, C10 and C30
- › Easy to dismantle



# TC1

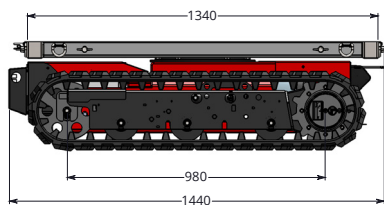
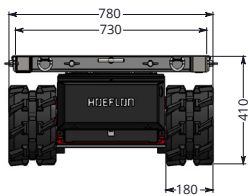

📦 Max. 1.200kg

📏 1,4 x 0,78 x 0,41m

⚖️ 500kg

- › Compact, strong and robust
- › Easy to attach load
- › Adjustable platform
- › Very quiet due to electric drive

# Lifting beam

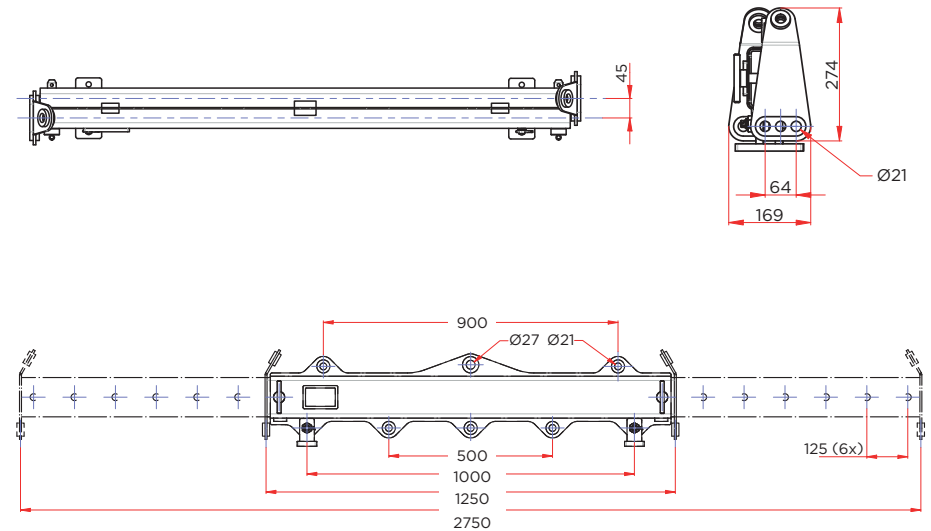



- 📏 Max. 1.200 - 6.000kg
- 📦 1,25 x 0,17 x 0,27m
- ⚖️ 45kg

- › Low net weight
- › Compact dimensions
- › Flexible adjustment
- › High capacity

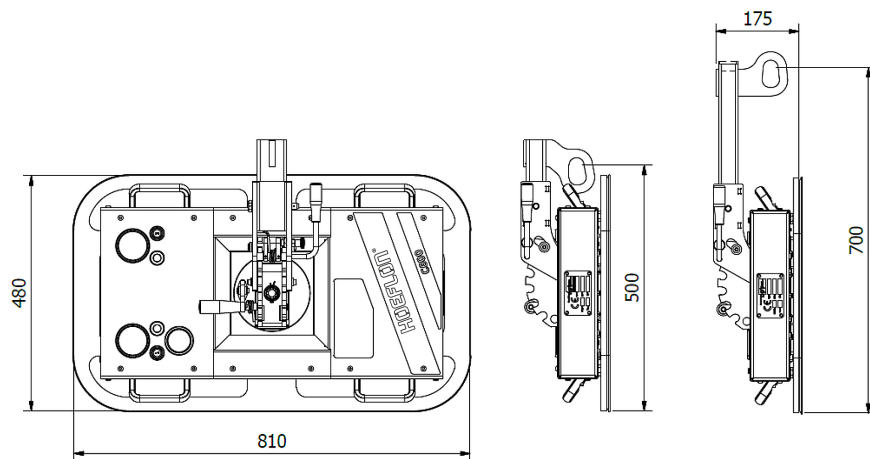
# C600



 300 / 600kg  
 30kg

- › Low net weight
- › Short attachment possible (bevelled buffers)
- › Endless rotation with stop every 90°
- › Double circuit for extra safety
- › Transport cart
- › Remote control

# S600

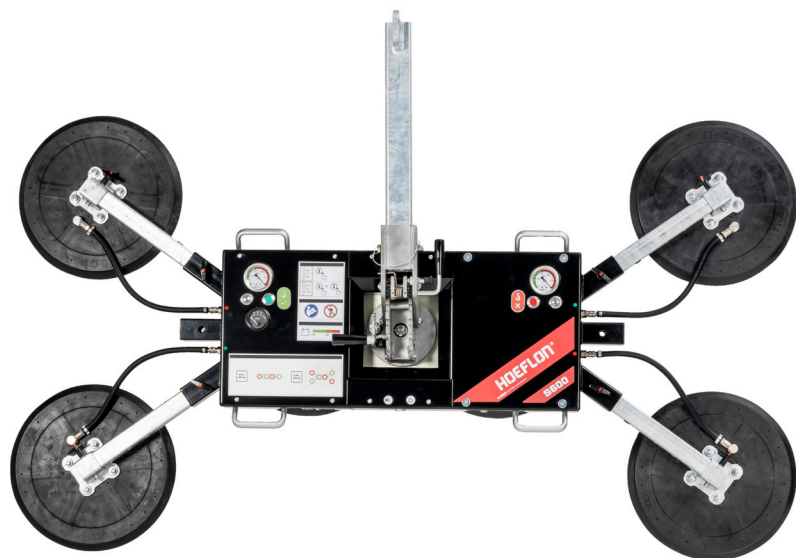

600 kg

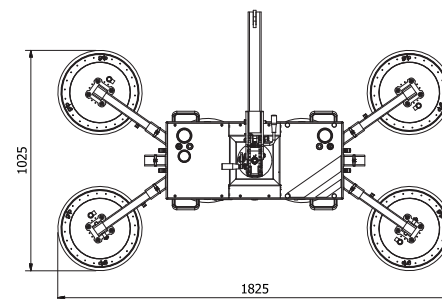

400 kg

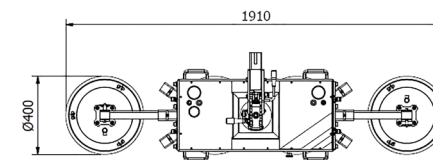

400 kg

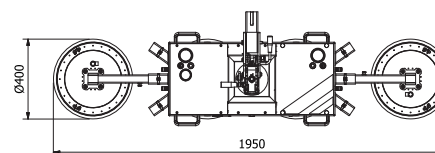

200 kg

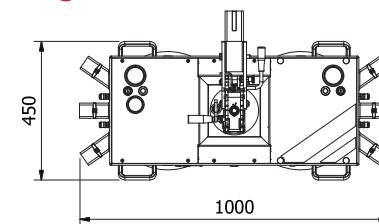

- Max. 600kg
- 50 - 70kg

- › Endless rotation with stop every 90°
- › Double circuit for extra safety
- › Transport cart
- › Remote control
- › Swappable battery system incl. spare battery
- › Protective covers for suction cups

# S800

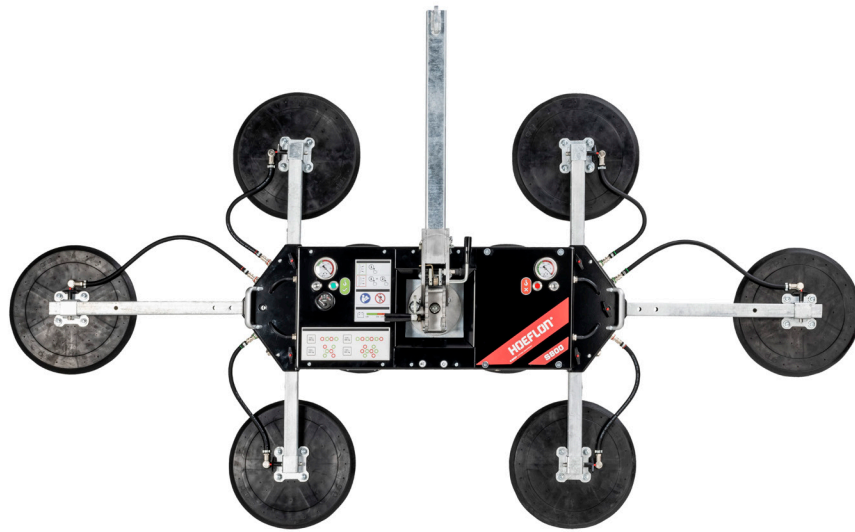

800 kg

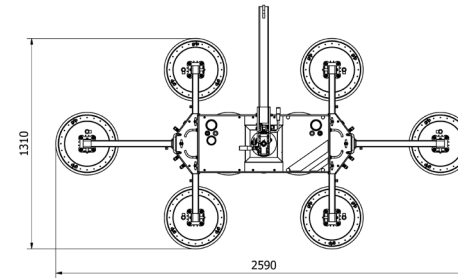

400 kg

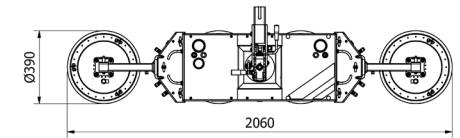

600 kg

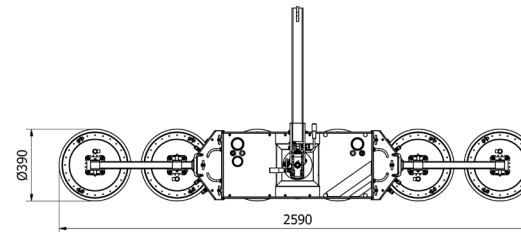

200 kg

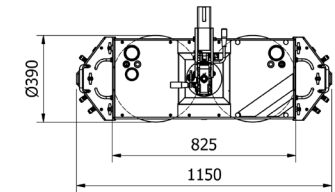

- ⚖ Max. 800kg
- 📦 55 - 80kg

- › Endless rotation with stop every 90°
- › Double circuit for extra safety
- › Transport cart
- › Remote control
- › Swappable battery system incl. spare battery
- › Protective covers for suction cups

# S1000



600 kg

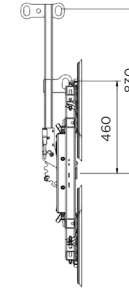
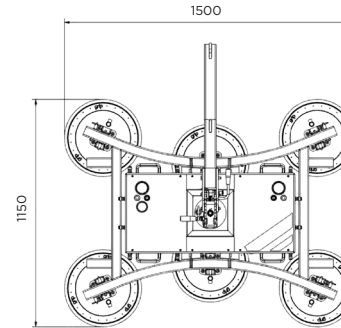

1000 kg

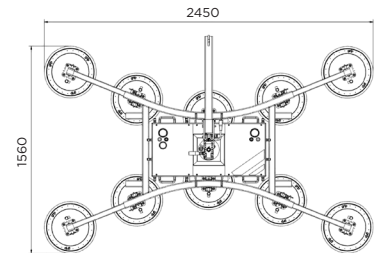

1000 kg

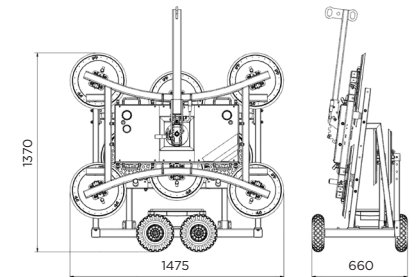
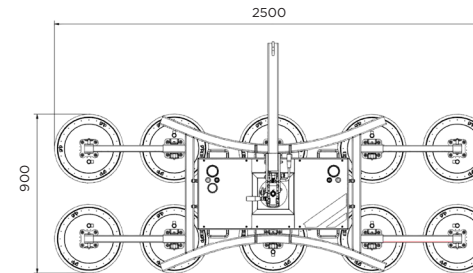

- Max. 1.000kg
- 85 - 110kg

- Endless rotation with stop every 90°
- Double circuit for extra safety
- Transport cart
- Remote control
- Swappable battery system incl. spare battery
- Protective covers for suction cups

# CX5-L

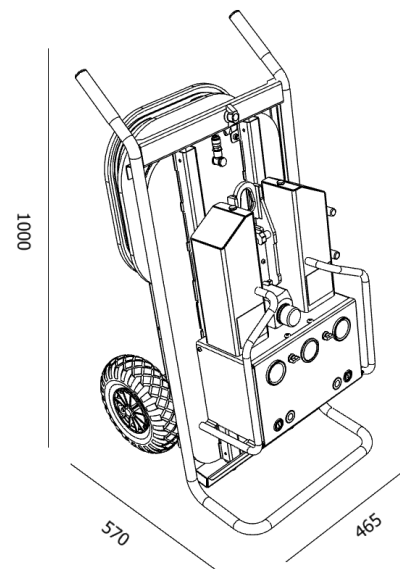
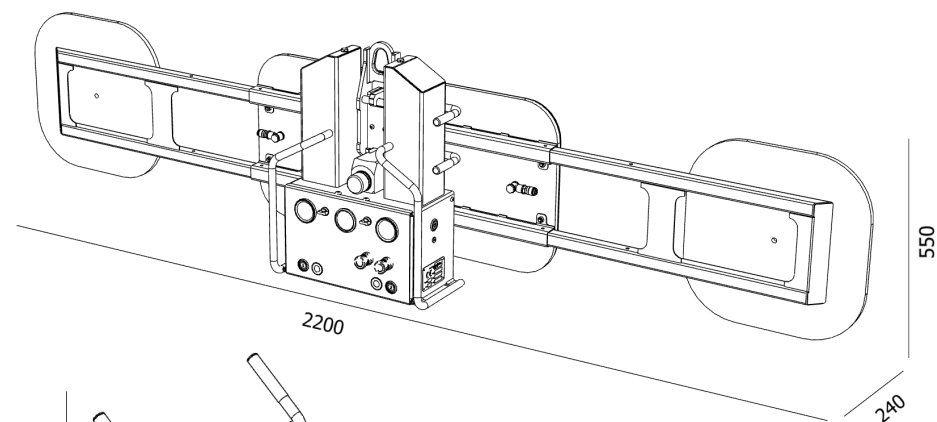
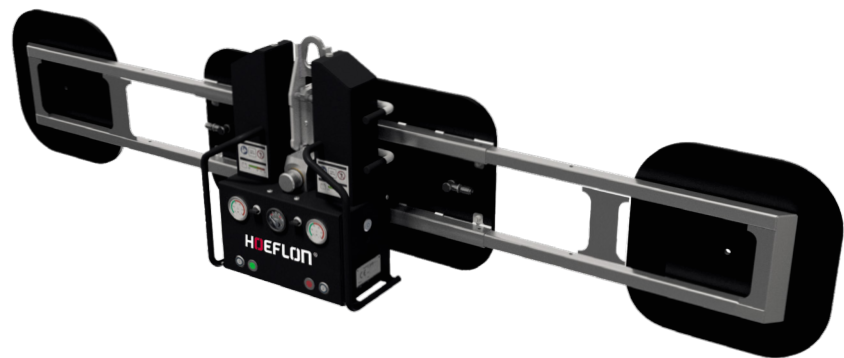

⚖ Max. 500kg  
📦 50kg

- › Endless rotation with stop every 90°
- › Double circuit for extra safety
- › Transport cart
- › Remote control
- › Swappable battery system incl. spare battery
- › Protective cover

Hoeflon and service

# Solution guaranteed!



Hoeflon stands for quality. In the unlikely event of a problem, we will solve it! Service is of paramount importance. The primary objective is ensuring that the crane is back in service as quickly as possible. Local service shops, service vans and trained service technicians are present in all markets that Hoeflon serves. This is your guarantee that you will be back to work in no time!

## Hoeflink

- 1 Remote support
- 2 Up to three weeks of history available for review
- 3 Calculate the outrigger pressure of each machine for every situation
- 4 Access to the Hoeflon support database with explanatory videos, user manuals and more

1

2

3

4





**HOEFLON®**

**Hoeflon International B.V.**

Zwolleweg 2

3771 NR Barneveld, NL

+31 (0)342 400 288

[sales@hoeflon.com](mailto:sales@hoeflon.com)

[www.hoeflon.com](http://www.hoeflon.com)